

# User's Manual

Product Name: Electric Pedal Bracket For 2021+ ChangAn UNI-K

## 1. Precautions

- 1.1 Please read the User's Manual carefully before installation. Pay attention to the outside appearance during operation in case of any scratch;
- 1.2 Please check regularly if all the connecting components are fixed tightly to ensure safety in use.
- 1.3 About the cable connection, Please follow the installation instructions strictly.
- 1.4 The ECU can't be flushed and soaked, Please note the location of the installation.
- 1.5 The ECU and cable must avoid engine casing, exhaust pipe and other high-temperature components.
- 1.6 It must avoid short circuit of 2 signal cables or with the vehicle body.
- 1.7 Tighten the connector of the motor for better waterproofing.

## 2. Preparation work

- 2.1 Check whether the product is in good condition and whether the accessories are complete.
- 2.2 Get the installation tools ready.

			
internal hexagonal wrench	knife	scissor	warped board
			
Double hexagonal socket wrench	slot type/cross screwdriver	socket spanner	open spanner

### 3. Accessories

No.	Name	Qty	Size	No.	Name	Qty	Size
(1)	Pedal	2		(8)	Plastic piece	8	M10
(2)	Front Bracket	2		(9)	warranty card	1	无
(3)	Rear Bracket	2		(10)	U-shape bolt	10	无
(4)	ECU	1		(11)	M10X35 screw	2	56X16X15
(5)	hexagon socket head cap screw	8	M6*20	(12)	M10X35 screw	10	48X14X11
(6)	electrical adhesive tape	1		(13)	hexagon nuts with flange	12	M10 nut
(7)	Nylon cable ties	25					

### 4. ECU & Cable



**Main cable**



**ECU**



**positive pole  
negative pole**



**motor counter**

## 5. Cable connection

5.1 Cut the plug below and connect the cable (red and black) to the car using red cable clamp.

The pic below is the position of the connection of 2021+ ChangAn UNI-K

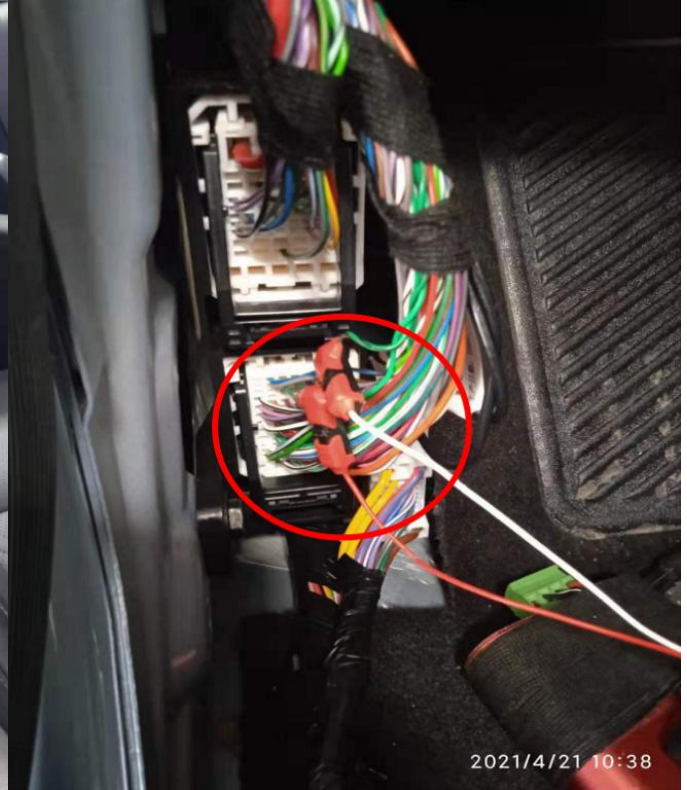

Disassemble the interior panel of the cab show above

Find the twist cable

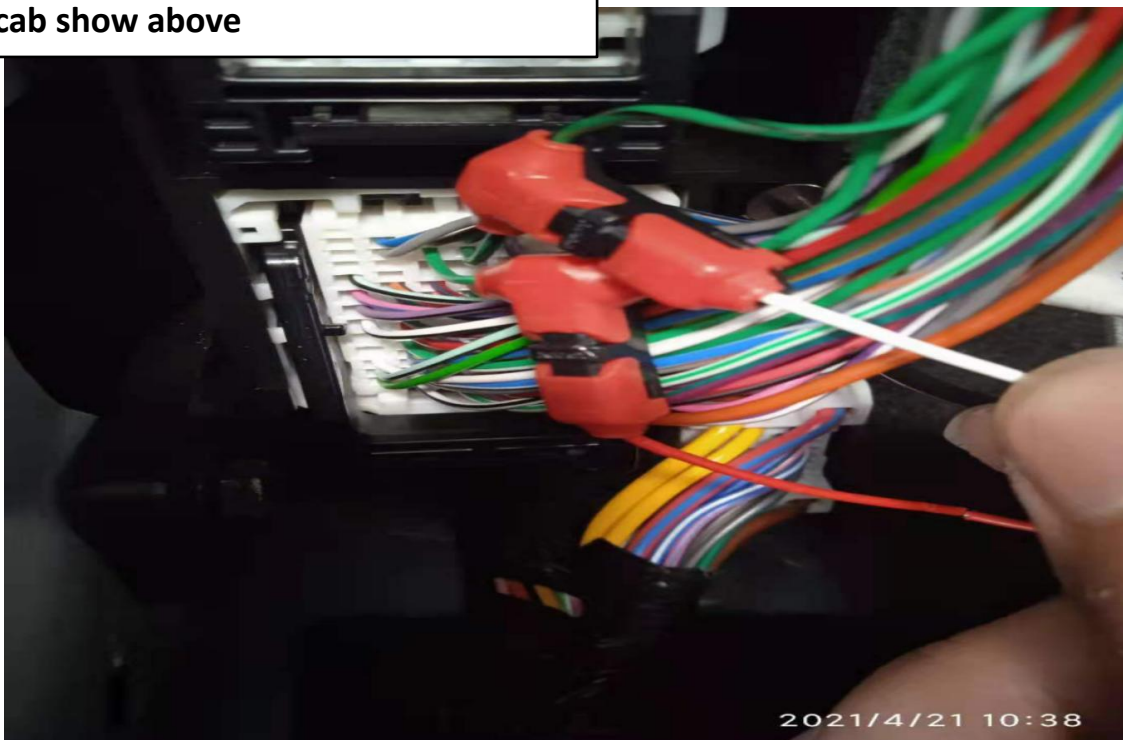

Find the twist cable

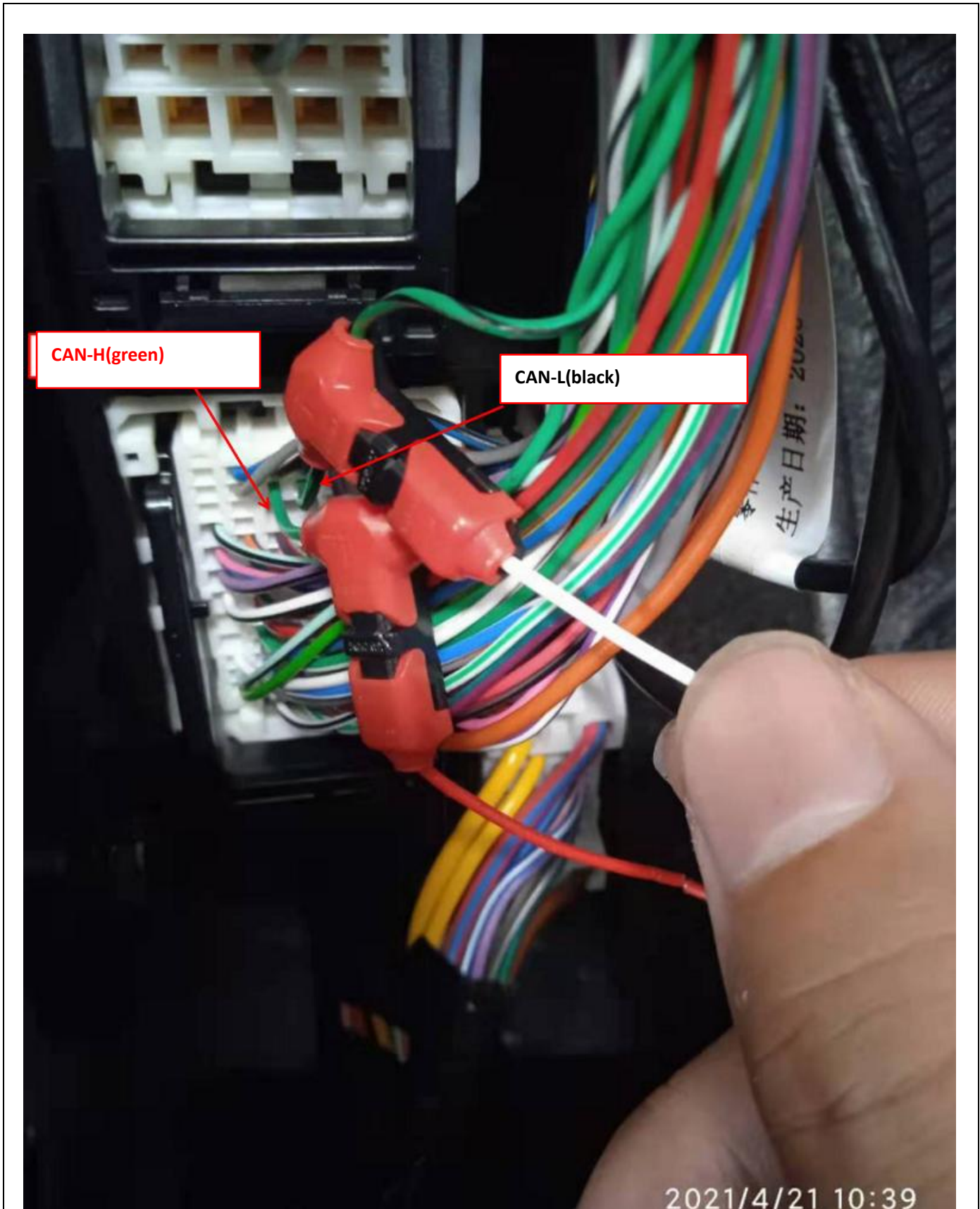

**CAN-H to the red cable**

**CAN-L to the black cable**

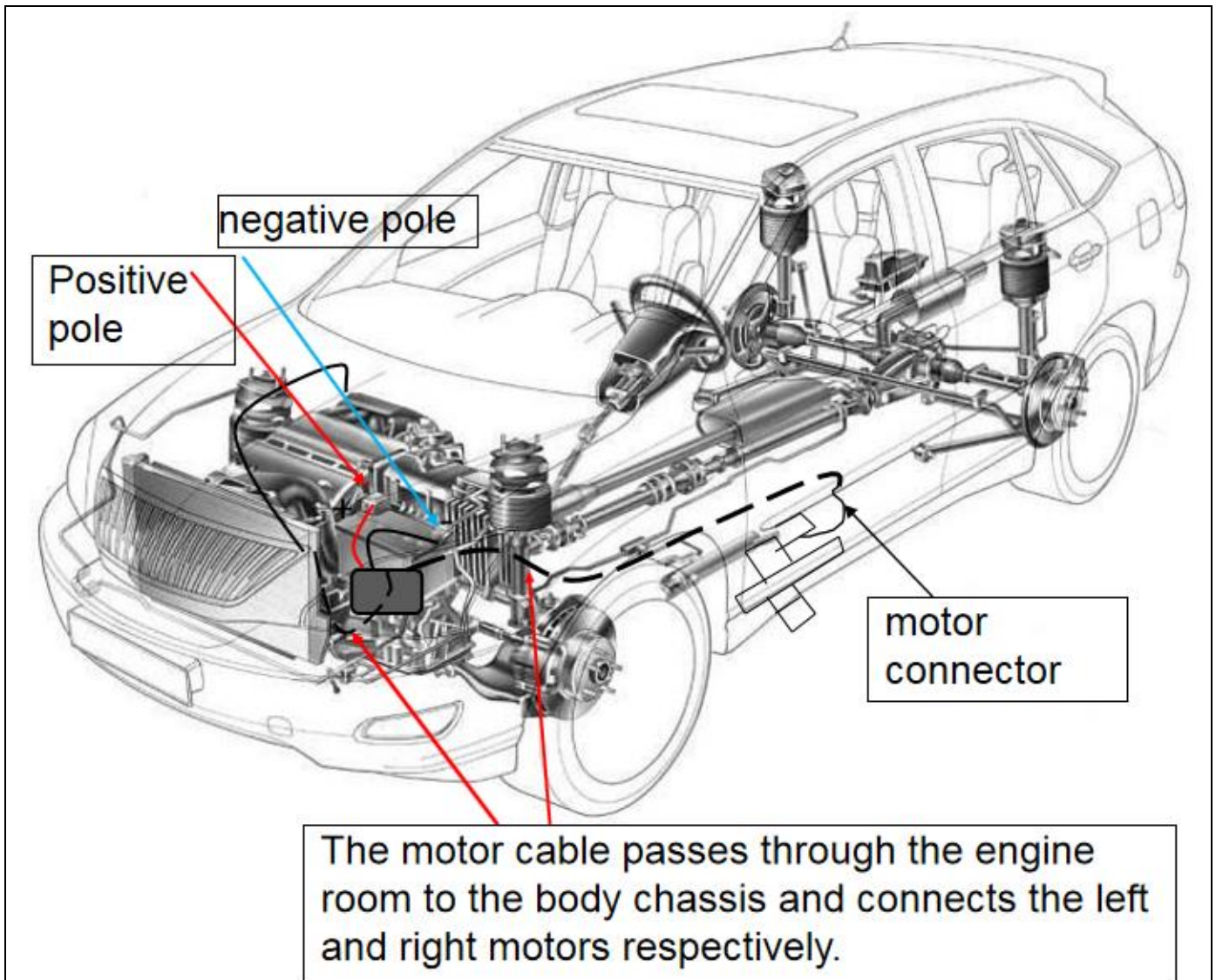

## 6. Installation

- 6.1 Refer to the accessories list to check whether the accessories are complete.
- 6.2 Distinguish the front, back, right and left sides of the bracket, Then place it in place with the fastener for improving the speed of installation
- 6.3 Insert the corresponding t-bolt into the plastic card respectively, In order to avoid the loading process can not be completed due to the wrong operation of t-type screws inserted into the car bottom plate.

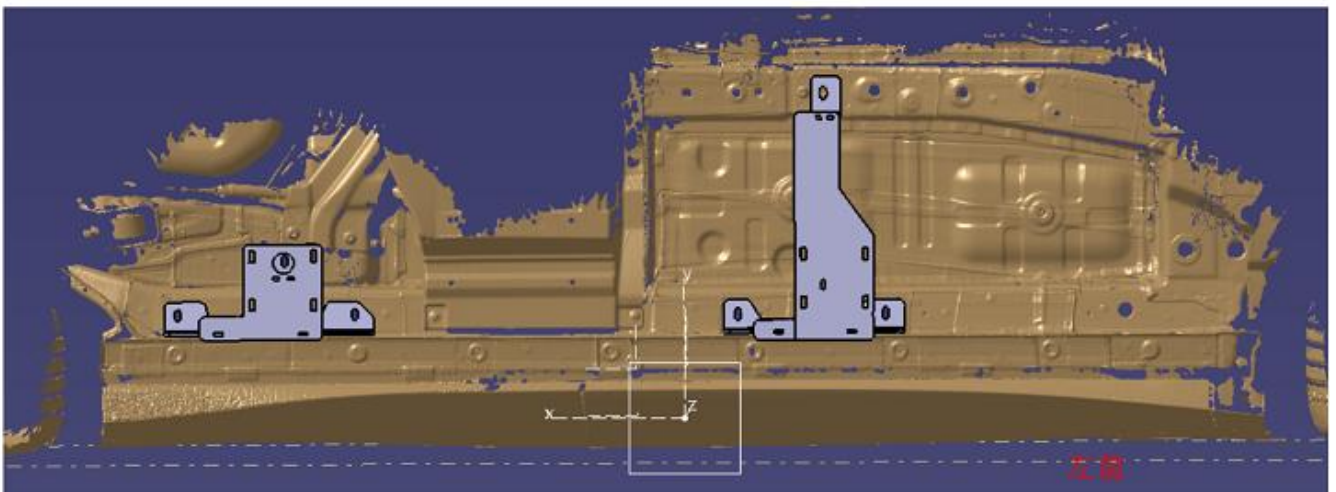
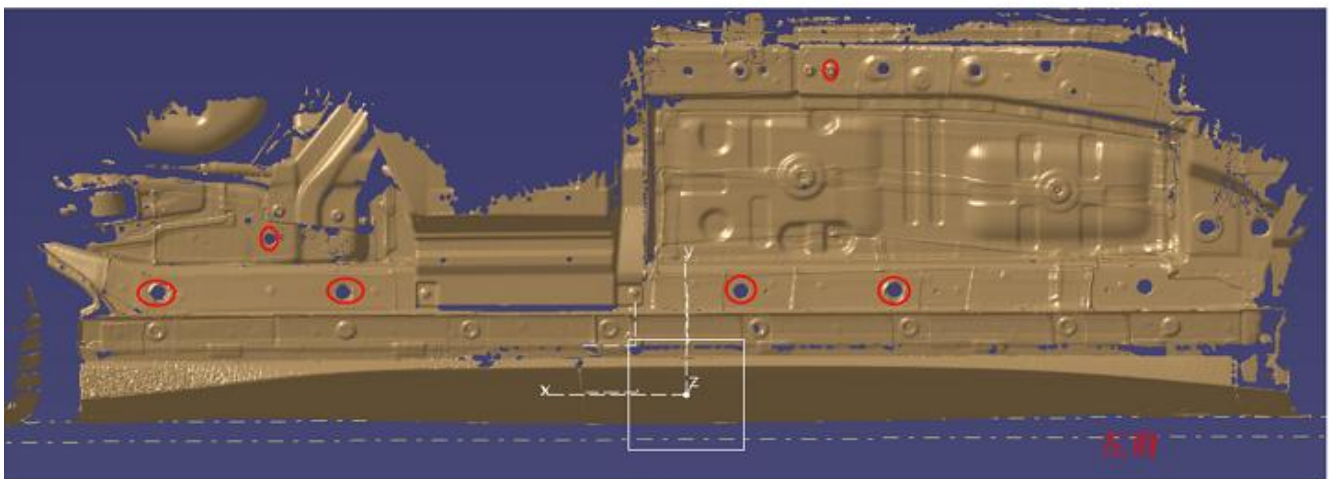
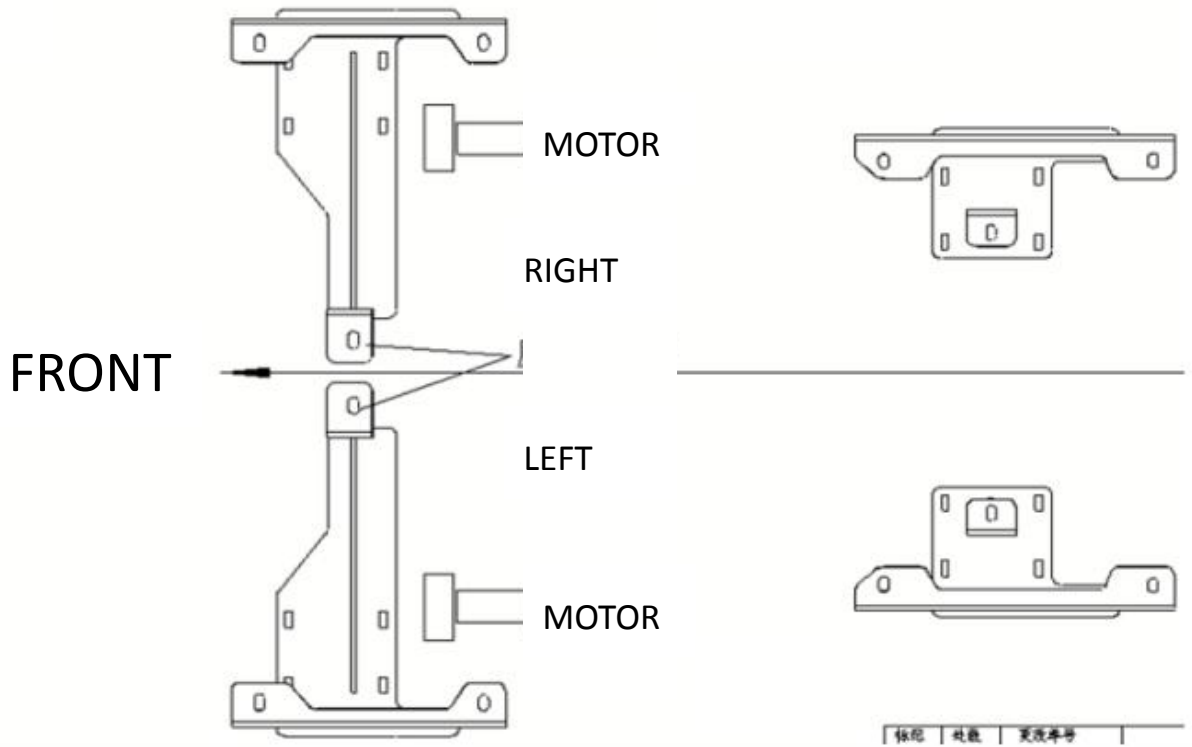

6.4 Organize the string with tie tape ,Install the removed guard plate in its original position[If there is interference between the guard plate and the bracket, the interference part should be removed].

6.5 The installation is completed, check whether there is any omission in the above installation steps.

**7.Disclaimer:**

Installation must be carried out in accordance with this manual. The related problems and losses caused by improper installation and use are not covered by our warranty.